

#	Qty	PART NUMBER	DESCRIPTION
1	4	31-005	HANDLE - RECESSED/LOGO/ZINC
2	8	32-016	CORNER - BALL/WITH CLAMP/ZINC
3	8	34-013	CATCH - RECESSED W/OFFSET/ZINC
4	8	35-007	CLAMP - SMALL/OFFSET
5	4	40-001	FOOT - RUBBER/1-1/2"
6	2	41-012	RACK RAIL-12 SPACE
7	1	83-012	BADGE - GRUNDORF TOUR 8 SERIES

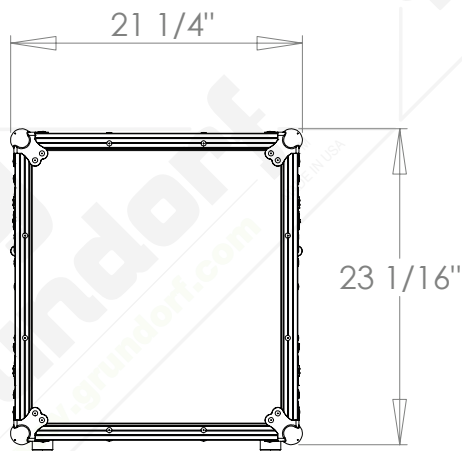

FRONT VIEW

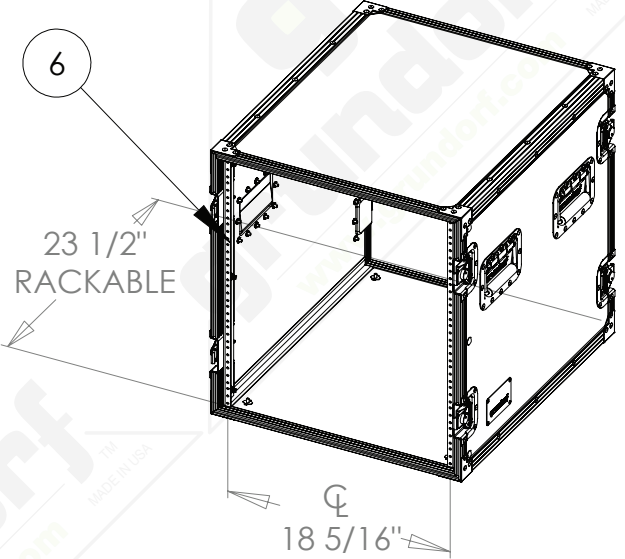
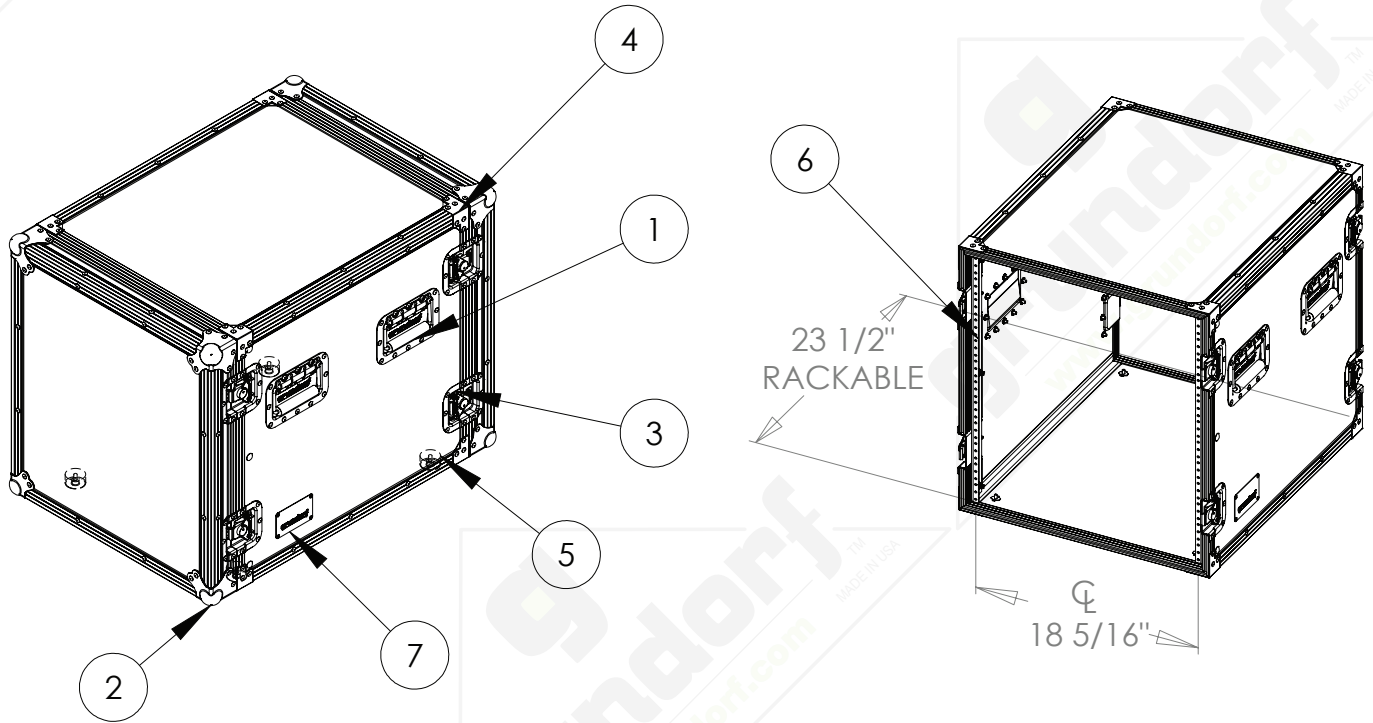
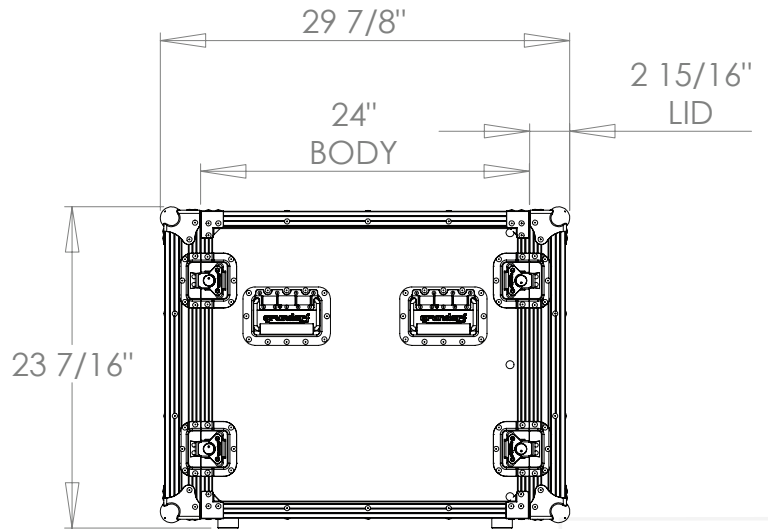

SIDE VIEW